

BUSINESS REGULATORY DEPARTMENT

Division of Economic Development

NAVAJO PROCUREMENT PROCESS

AMENDED 2 NNC § 164, 185, 222, 223
12 NNC § 301-371 NAVAJO PROCUREMENT CODE
5 NNC § 201-216 NAVAJO BUSINESS OPPORTUNITY ACT



OCTOBER 2003

SUMMARY OF AMENDMENTS EFFECTIVE - APRIL 19, 2002

THE NAME OF THE LAW IS CHANGED



Old Name : NAVAJO BUSINESS PREFERENCE LAW

New Name : NAVAJO BUSINESS OPPORTUNITY ACT



CITATION OF THE LAW CHANGED

(5 NNC § 201-218) is now (5 NNC § 201-216)

The original Section 214 & 216 were deleted in its entirety

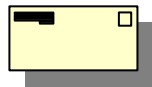
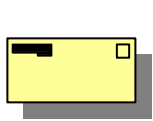

ADVERTISEMENT REQUIREMENTS HAVE CHANGED

ALL PROCUREMENTS OVER \$50,000 MUST BE PUBLICLY ADVERTISED
AND BIDDED.

(Threshold requirements have changed from \$2,500 to \$50,000)



THE WORDING "OPPORTUNITY FOR NEGOTIATION" HAS BEEN DELETED
FROM THE NAVAJO BUSINESS OPPORTUNITY ACT.



(CLE/PP may negotiate with bidders)



PRIORITY STATUS & REQUIREMENT

Priority # One - 100% Navajo owned & controlled business entity.

Priority # Two - Navajo businesses that are less than 100% owned and controlled but has majority of ownership and control of a business.

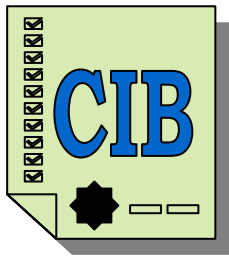

- Other Indians that own and control a majority or all of the business activities.
- Any tribally owned and operated business entities (enterprises) are priority # twos.

Priorities have changed from FOUR to TWO.

(Location is no longer a Factor in determining Priority)

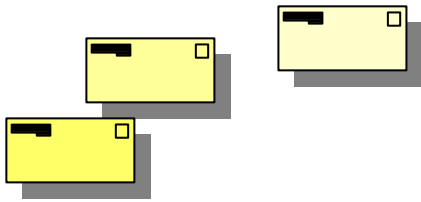

RE-BID PROVISIONS HAVE CHANGED

Any changes, modifications and extensions to an original contract that Results in a change of cost by more than 20% SHALL BE RE-BIDDED.

(The re-bid provision was at 10%)

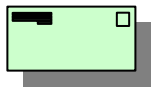
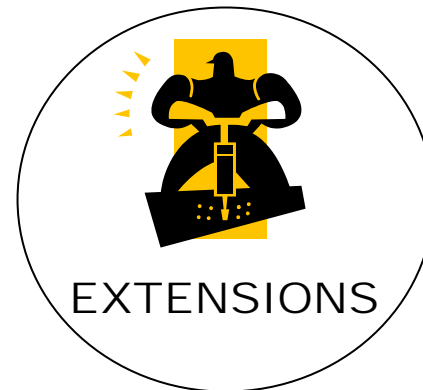

BUSINESS REGULATORY DEPARTMENT

Division of Economic Development

NAVAJO BUSINESS OPPORTUNITY ACT

5 NNC § 205 NAVAJO BUSINESS OPPORTUNITY ACT
ADVERTISEMENT AND NOTICE
BID OPENING PROCEDURES



OCTOBER 2003

PROCUREMENT PROCESS

--

PROCUREMENTS GREATER THAN \$50,000

(5 NNC § 201 et. seq.)

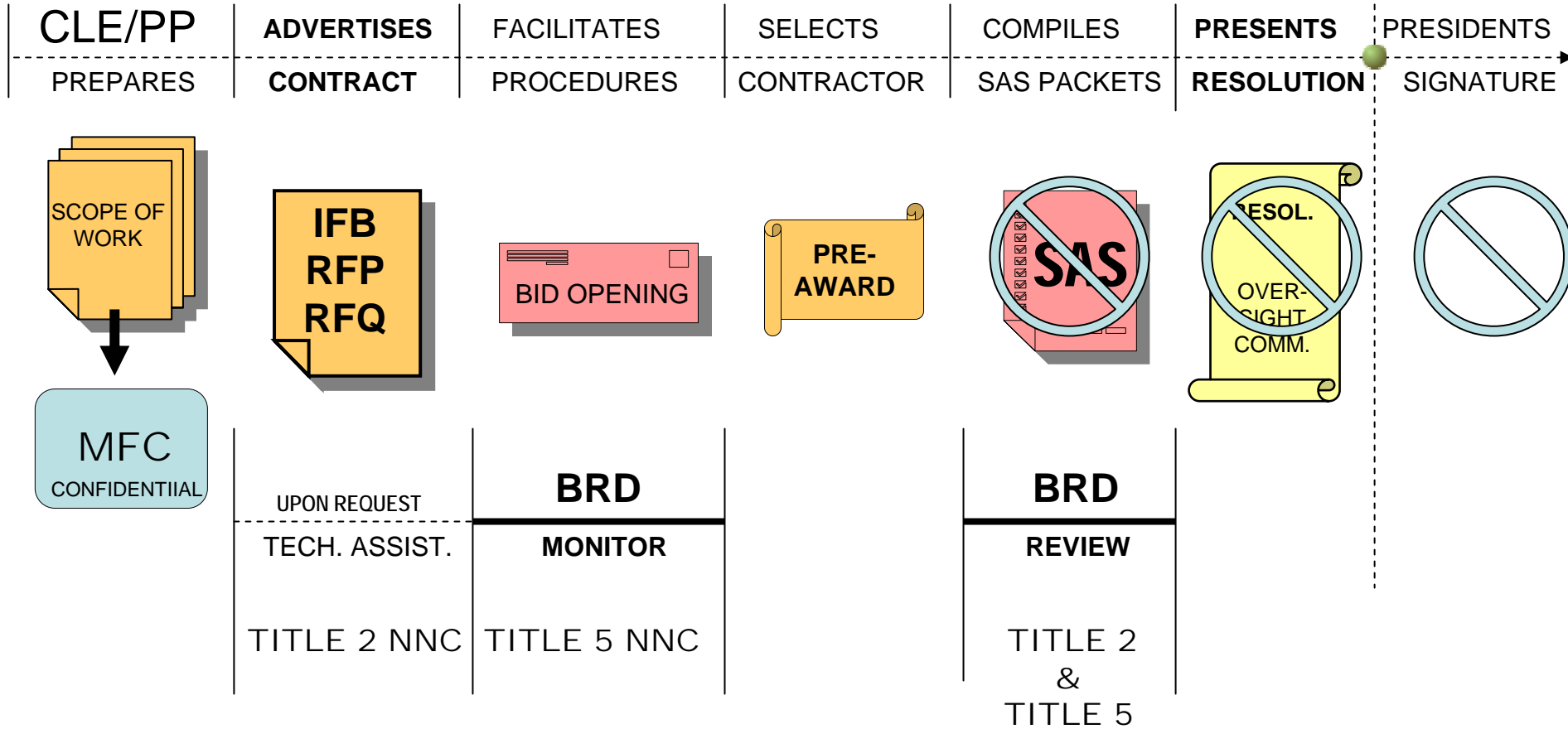

**BUSINESS REGULATORY DEPARTMENT
DIVISION OF ECONOMIC DEVELOPMENT**

PROCUREMENT PROCESS

--

PROCUREMENTS GREATER THAN \$50,000

(5 N.N.C. §201 et. seq.)

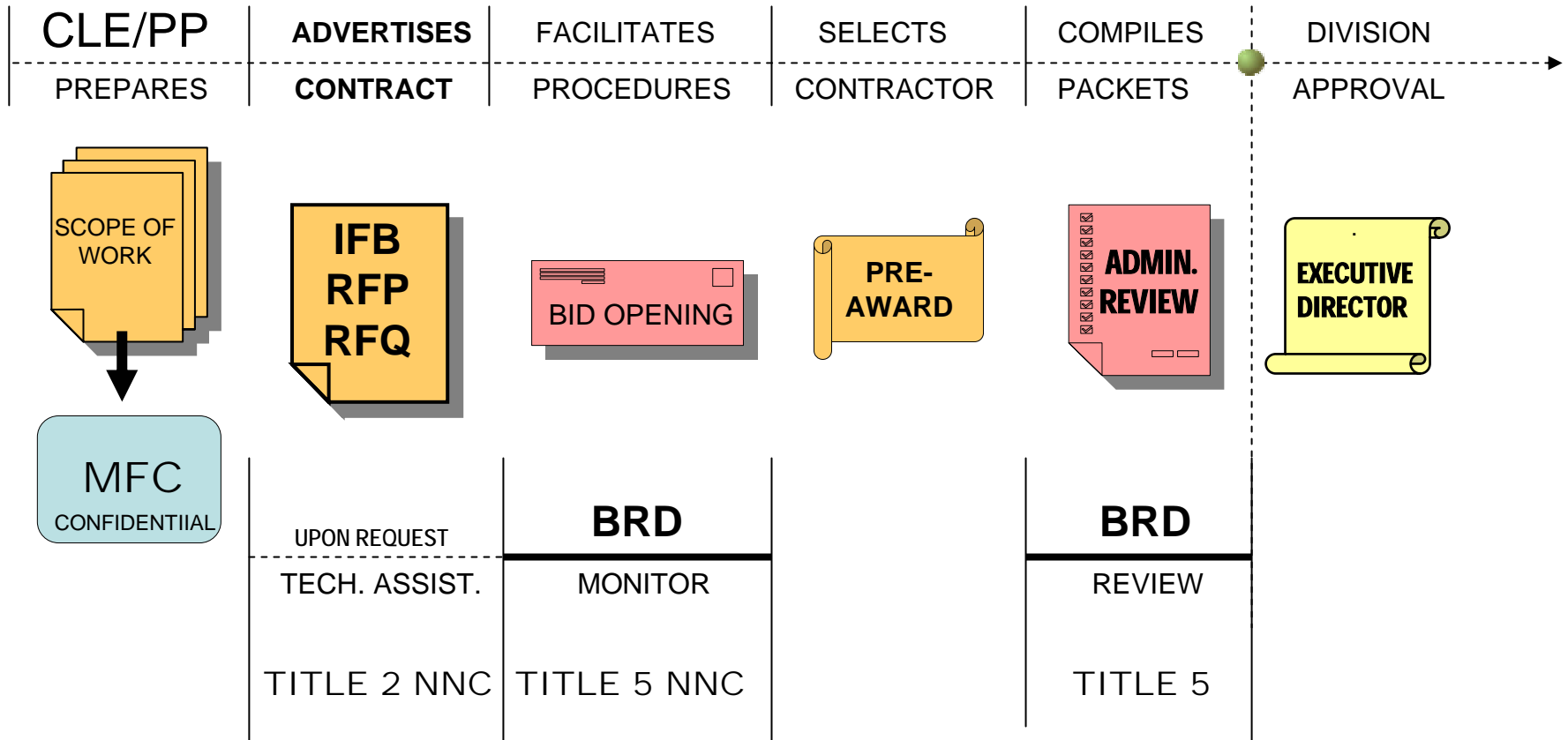

**BUSINESS REGULATORY DEPARTMENT
DIVISION OF ECONOMIC DEVELOPMENT**

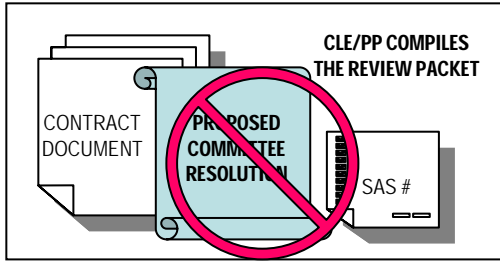

PROGRAM & DIVISION SIGNATURE



CLEARANCE & SIGNATURE



REVIEW & SIGN



REVIEW & SIGN

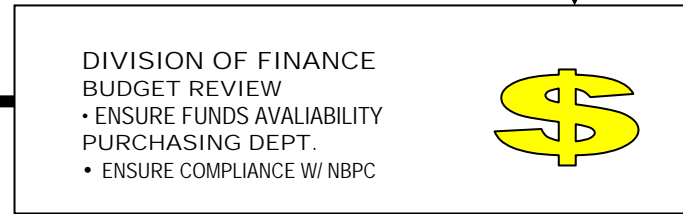

REVIEW & SIGN



REVIEW & SIGN



REVIEW & SIGN



OR



SAS - 164 REVIEW

OVERSIGHT COMMITTEE ACTION REQUIRED

PROCUREMENTS GREATER THAN \$50,000

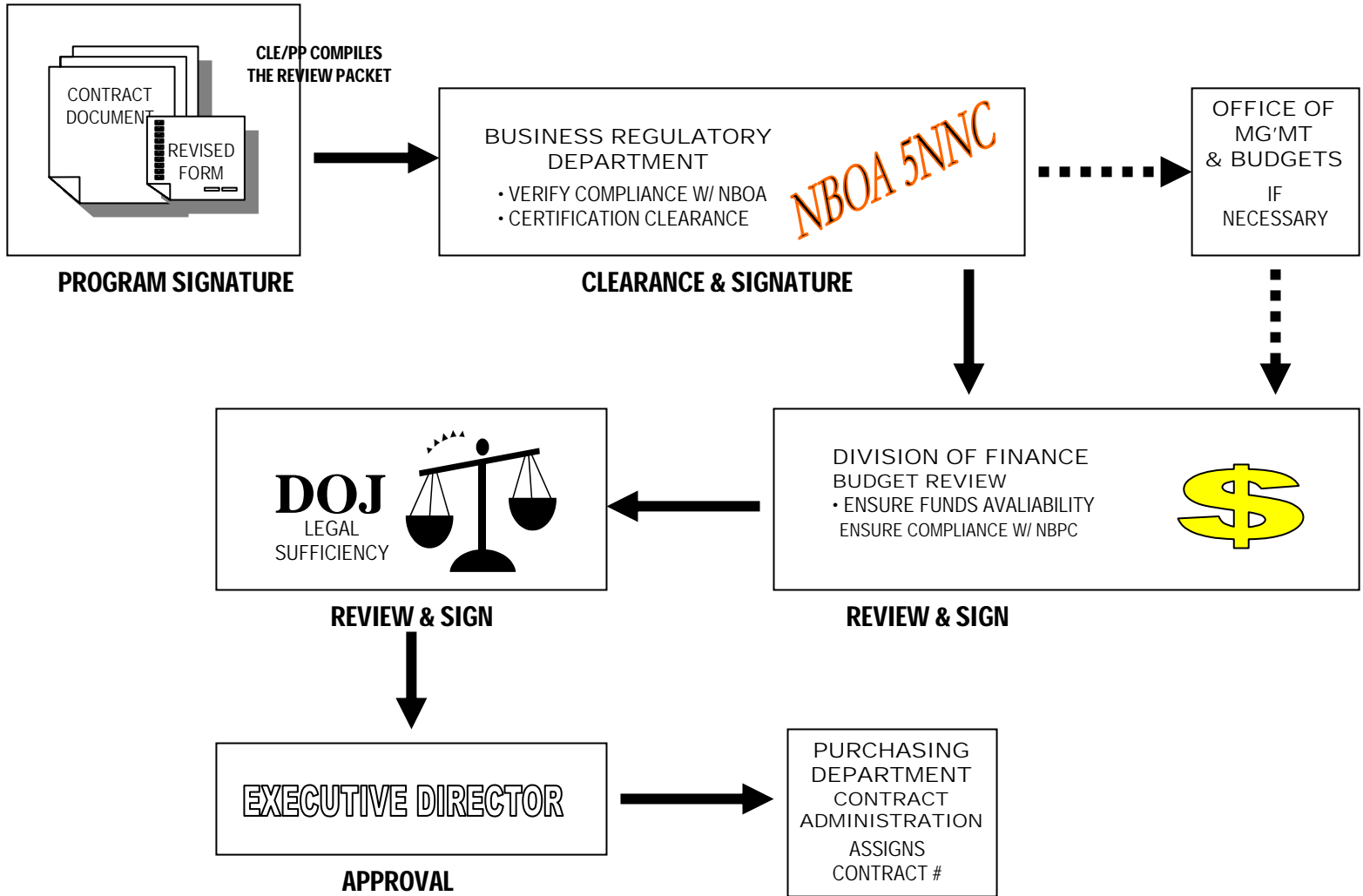

ADMINISTRATIVE REVIEW
BUSINESS REGULATORY DEPARTMENT

ADMINISTRATIVE REVIEW

PROCUREMENTS LESS THAN \$50,000

(12 NNC § 301 et. seq.)

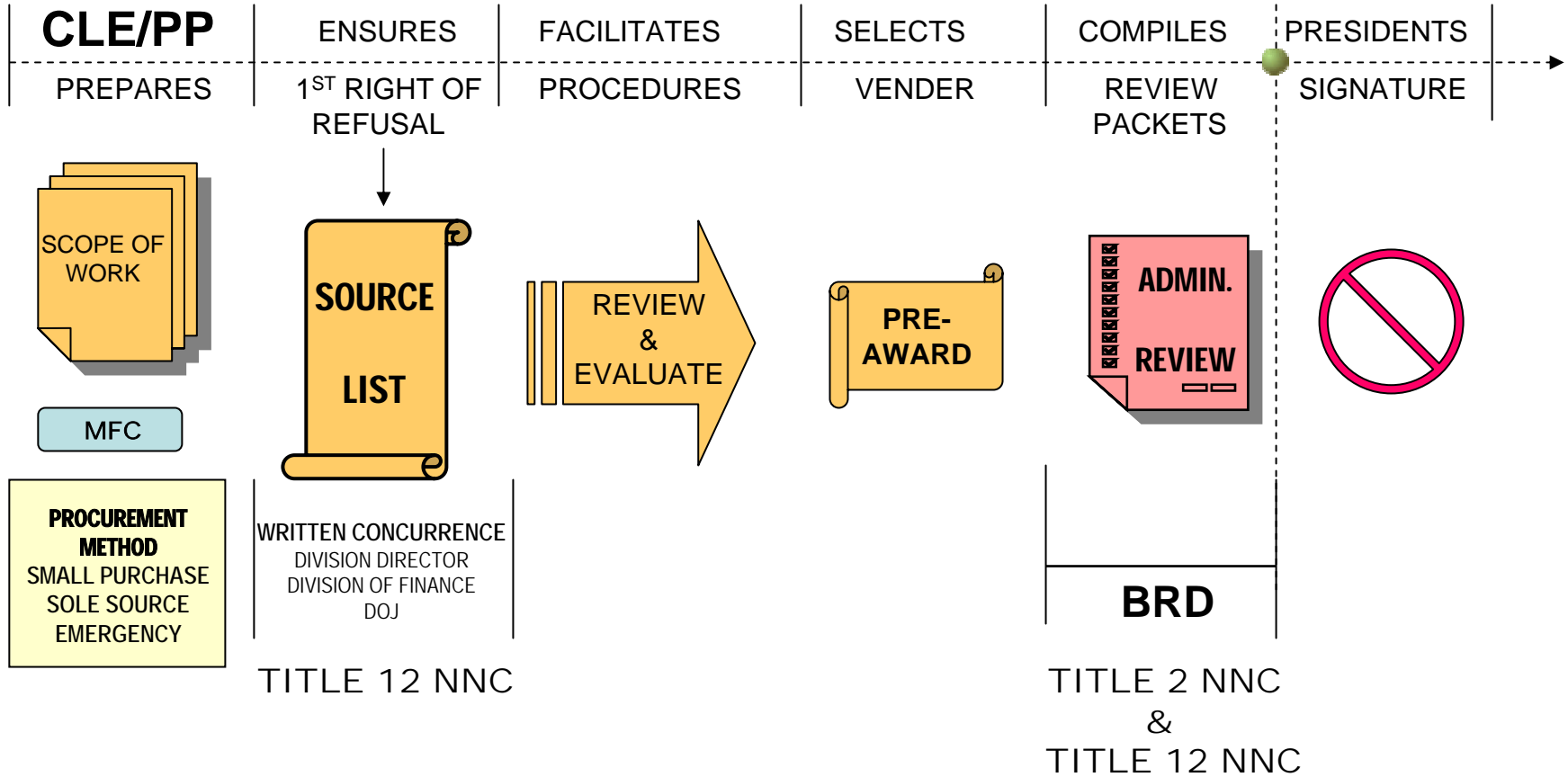

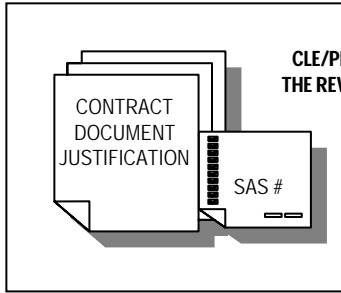

PROGRAM & DIVISION SIGNATURE



CLEARANCE & SIGNATURE



REVIEW & SIGN

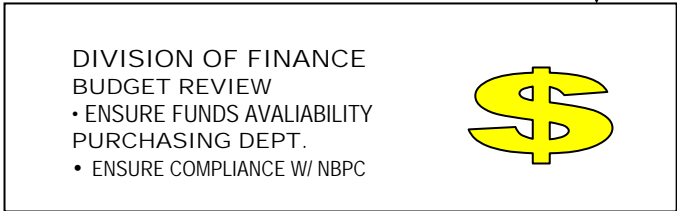

REVIEW & SIGN



REVIEW & SIGN



ADMINISTRATIVE REVIEW
PROCUREMENTS LESS THAN \$50,000

CLE/PP PREPARES ADVERTISEMENT FOR CONTRACTS

PUBLIC ADVERTISEMENT

REQUIRED FOR:
PROCUREMENTS OVER \$50,000

2 NNC § 223 (f)

UNLESS OTHERWISE AUTHORIZED
AS SMALL PURCHASE, EMERGENCY
PURCHASE OR SOLE SOURCE

5 NNC § 205 (B)

PRE-BID MEETING
(If Necessary)

SCOPE OF WORK

QUALIFICATIONS AND
LICENSE OR CREDENTIALS
REQUIRED

STATEMENT THAT
NBOA WILL APPLY

DEADLINE DATE
FOR BIDS

(All Bids received
after the deadline
date will be deemed
disqualified)

BID OPENING DATE
(Monitored by BRD)

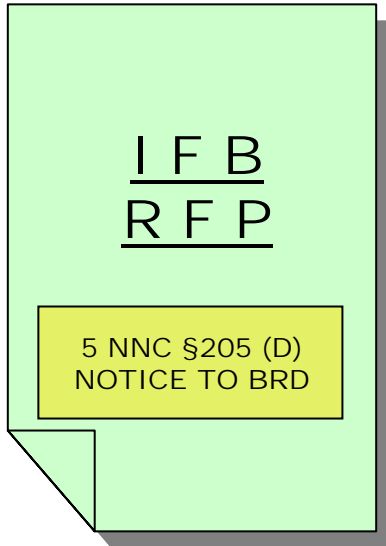

PROVIDE INVITATION

CLE/PP DETERMINES PROCUREMENT METHOD

ADMINISTRATIVE REVIEW PROCESS

USED FOR:
PROCUREMENTS LESS THAN \$50,000

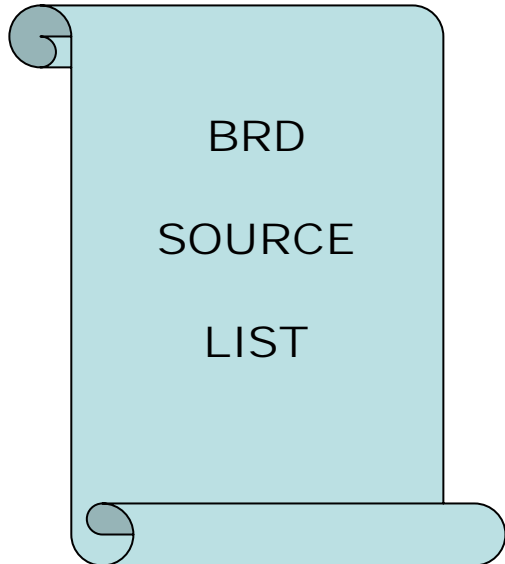

ALSO USED FOR:

- SOLE SOURCE PROCUREMENT
- EMERGENCY PROCUREMENT

12 NNC § 334

12 NNC § 335

ENSURE CERTIFIED BUSINESS 1ST. RIGHT OF REFUSAL

12 NNC § 333

REQUIRED SIGNATURES
PROGRAM DIRECTOR,
DIVISION DIRECTOR OR
OTHER PROCUREMENT
OFFICER

1
REVIEW SOURCE LIST,
CONTACT POTENTIAL
CERTIFIED BUSINESSES

2
REQUEST QUOTES FOR
TYPE OF WORK OR
SERVICES NEEDED

3
LIST BUSINESSES
CONTACTED AND
DOCUMENT FIRM'S
RESPONSES

4
JUSTIFICATION MEMO
AND SUPPORTING
DOCUMENTS

ADVERTISEMENT
I.F.B.

BIDDING PROCESS

1
PRE-BID MEETING

2
BID PACKETS
RECEIVED &
LOGGED IN
DATE & TIME

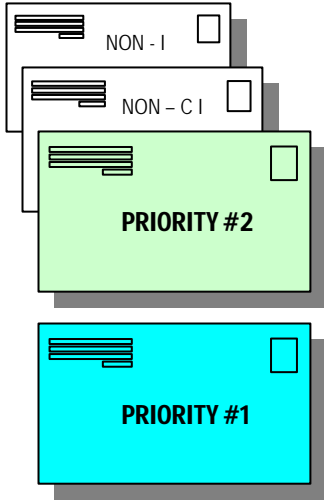

3
DEADLINE DATE
FOR BIDS →

4
BID OPENING DATE →

← ALL BIDS SUBMITTED AFTER THE
ESTABLISHED DEADLINE TIME AND
DATE SHALL BE DEEMED DISQUALIFIED

BID OPENING PROCEDURE

BUSINESS REGULATORY DEPARTMENT

ADVERTISEMENT
I.F.B.

BIDDING PROCESS

BID OPENING PROCEDURE

BUSINESS REGULATORY DEPARTMENT

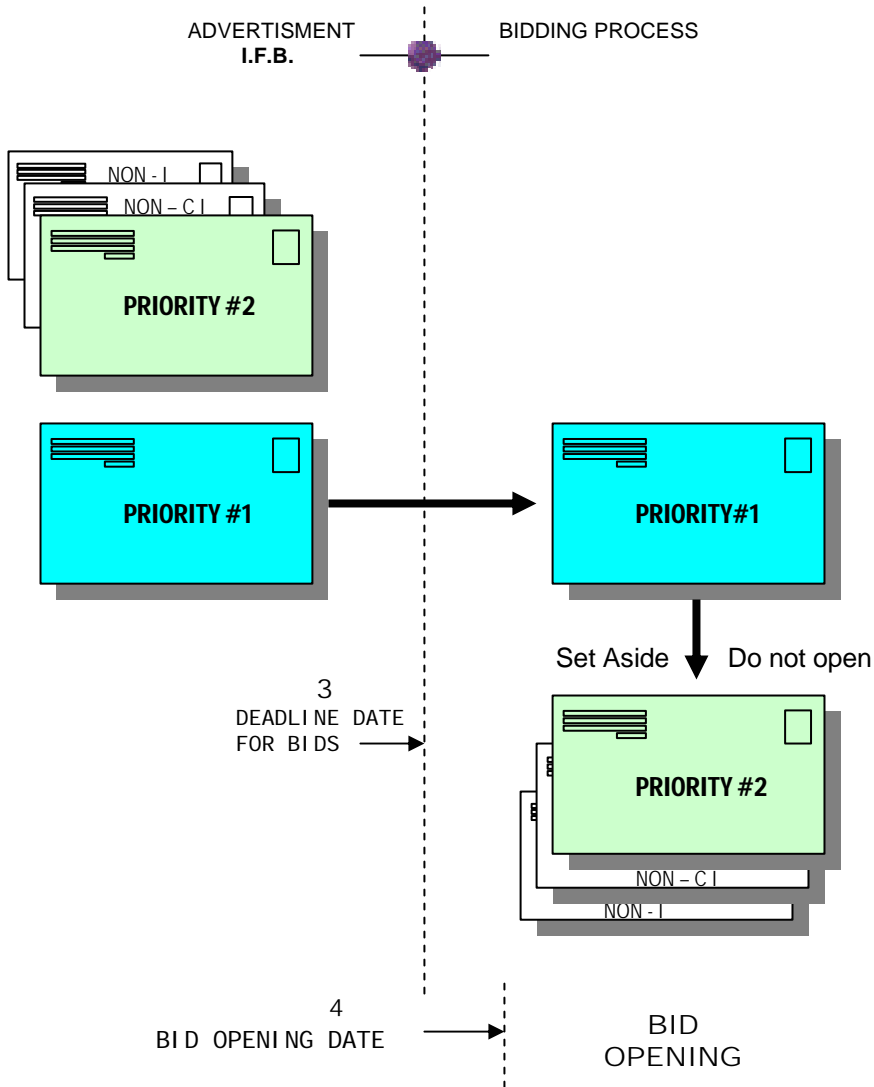

ADVERTISEMENT
I.F.B.

BIDDING PROCESS

BID OPENING PROCEDURE

BUSINESS REGULATORY DEPARTMENT

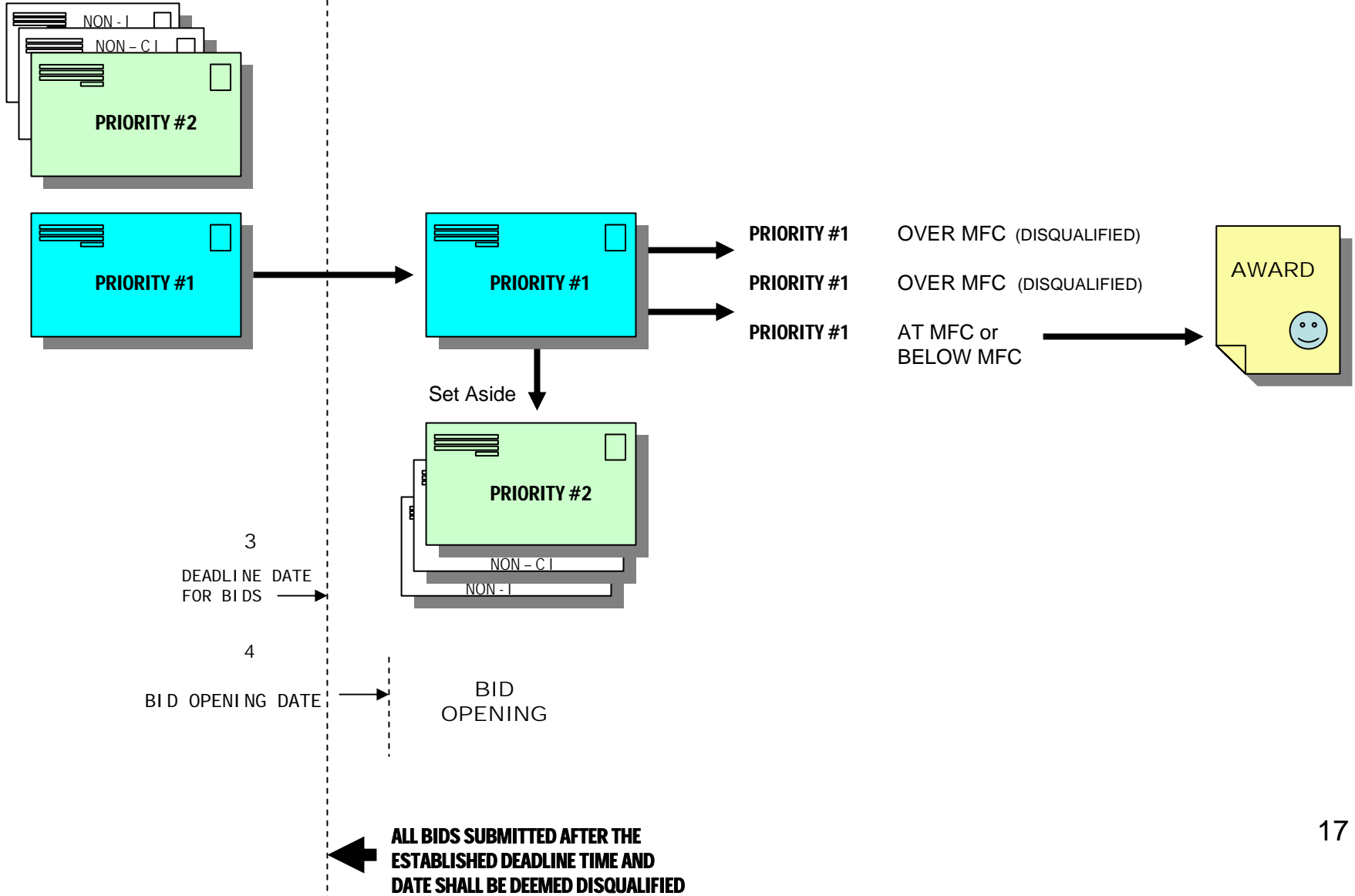

**IF ALL BIDS FROM QUALIFIED PRIORITY #1
EXCEED THE MAXIMUM FEASIBLE COST,
THE BID PROCESS CONTINUES WITH THE
OPENING OF PRIORITY #2 BIDS.**

THE FOLLOWING PROCESS WILL BE USED.

BID OPENING PROCEDURES

BUSINESS REGULATORY DEPARTMENT

ADVERTISEMENT
I.F.B.

BIDDING PROCESS

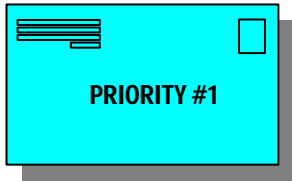
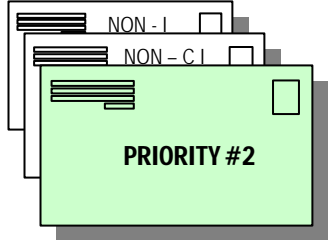

PRIORITY #1 OVER MFC

PRIORITY #1 OVER MFC

PRIORITY #1 OVER MFC

CLE may negotiate

Set Aside

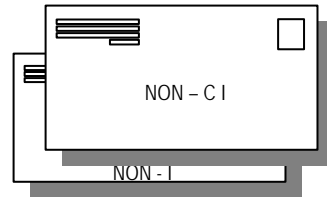
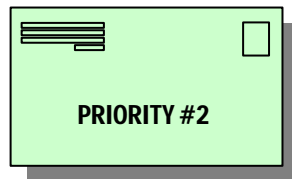

BID
OPENING

1
PRE-BID MEETING

2
BID PACKETS
RECEIVED &
LOGGED IN
DATE & TIME

3
DEADLINE DATE
FOR BIDS

BID OPENING PROCEDURES

BUSINESS REGULATORY DEPARTMENT

ADVERTISEMENT
I.F.B.

BIDDING PROCESS

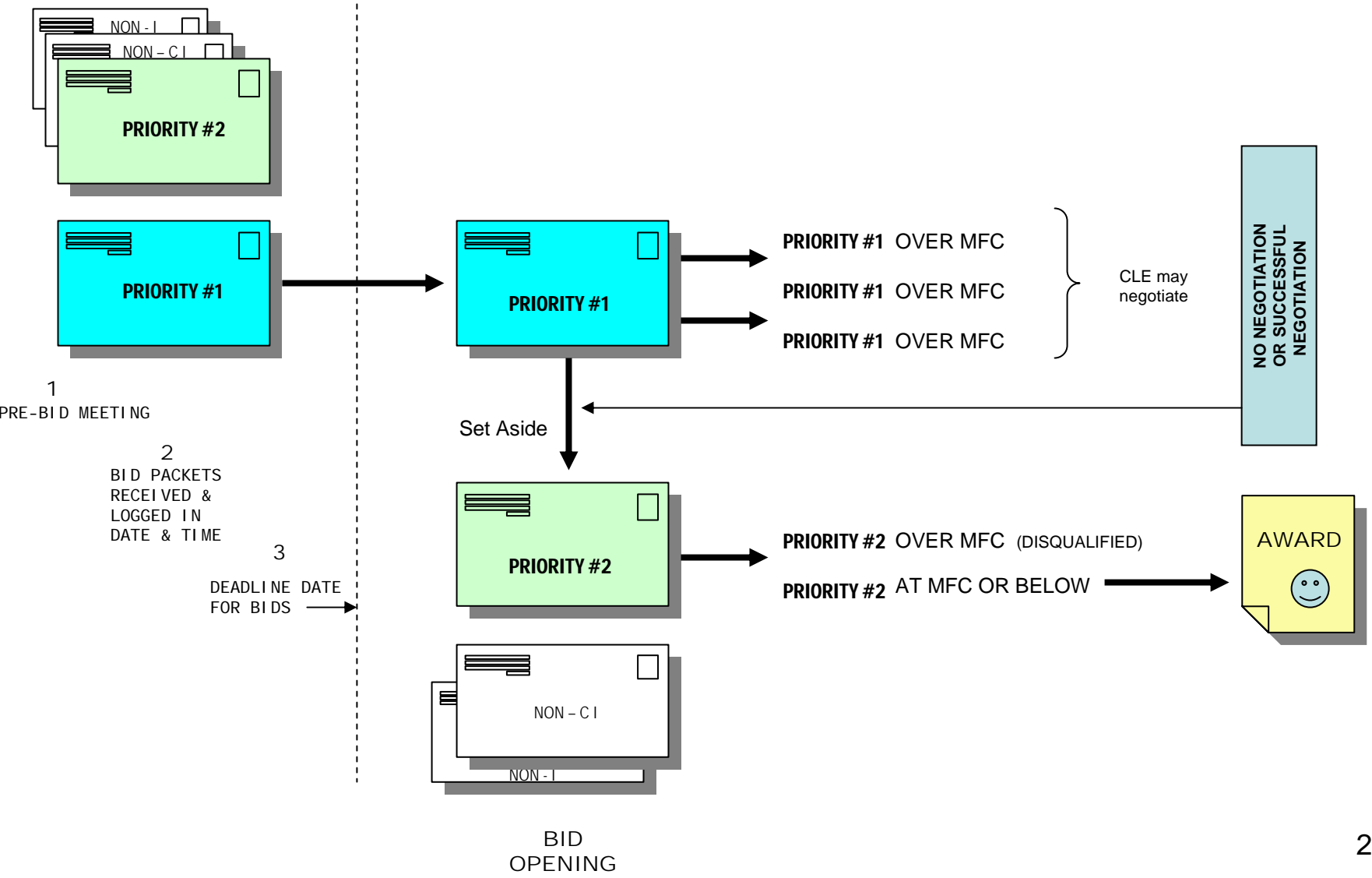

"ILLUSTRATION-2"

RFP / RFQ

A REQUEST FOR PROPOSAL IS USED TO QUALIFY PROPOSALS BASED UPON QUALITY AND SPECIFICATION OF THE CONTRACTING LETTING ENTITY.

AN RFP/RFQ REQUIRES TWO STEPS. THERE IS AN EVALUATION PHASE BEFORE THE BID COST ARE CONSIDERED.

THE FOLLOWING PROCESS WILL BE USED.

REQUEST FOR PROPOSAL METHOD

BUSINESS REGULATORY DEPARTMENT

REQUEST FOR PROPOSAL

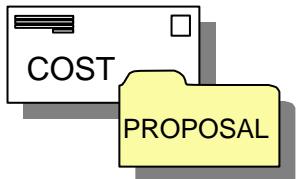
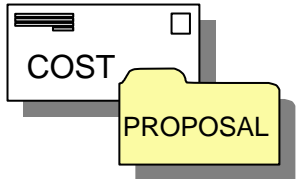
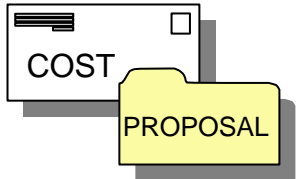
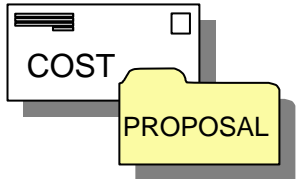
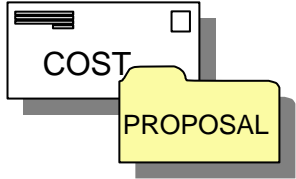

BID COST AND PROPOSALS ARE SEALED SEPARATE

1. AN RFP IS USED TO COMPARE DIFFERENT QUALITY AND CONTRACTUAL FACTORS BEFORE DECIDING ON THE AWARD.

2. THE MOST COMMON TYPES OF PROCUREMENT SERVICES TO BE COMPARED ARE AS FOLLOWS.

- Computer Services/Land Use Planning
- Laboratory/Testing Services
- Auditing/Accounting Services
- Training Services

**DEADLINE DATE:
ALL BIDS SUBMITTED AFTER
THE DEADLINE WILL BE
DEEMED DISQUALIFIED.**

REQUEST FOR PROPOSAL METHOD

BUSINESS REGULATORY DEPARTMENT

REQUEST FOR PROPOSAL



PHASE I
CLE/PP Sets the
Qualification
Standards

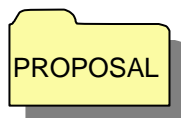
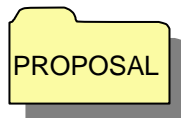
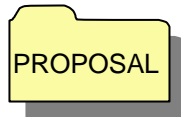
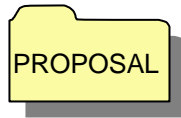
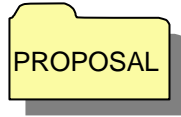

SOME QUALIFICATION FACTORS ARE BUT NOT LIMITED TO:

- 1. YEARS OF EXPERIENCE**
- 2. LICENSES/CERTIFICATES**
- 3. PAST PROJECTS/CREDENTIALS**
- 4. EVALUATION AND REVIEW OF QUALIFICATION MUST BE UNIFORMLY APPLIED.**

BID COST AND
PROPOSALS ARE
SEALED SEPARATE

CLE/PP SHALL
ACCEPT ALL
PROPOSALS

REQUEST FOR PROPOSAL METHOD

BUSINESS REGULATORY DEPARTMENT

REQUEST FOR PROPOSAL

PHASE I
REVIEW & EVALUATION

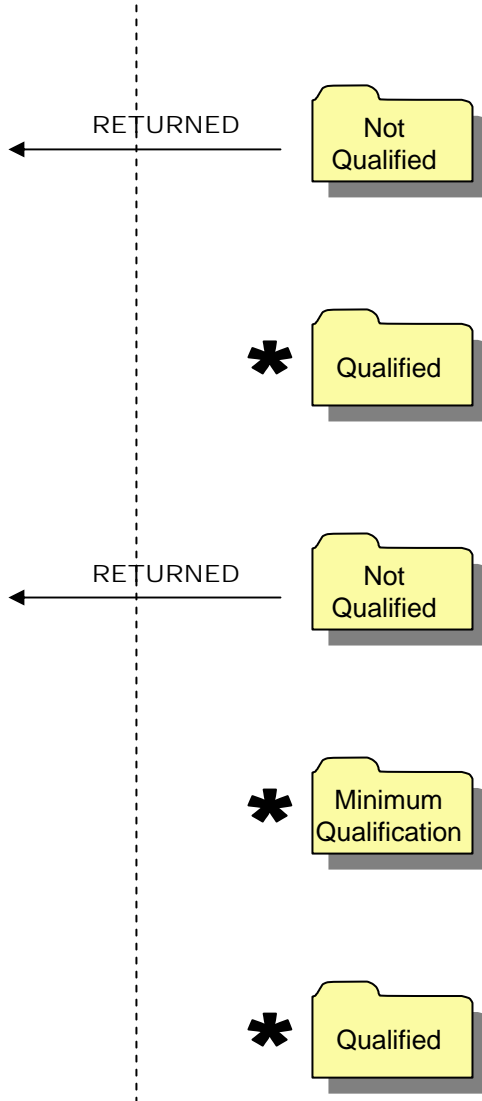

NAVAJO BUSINESS OPPORTUNITY ACT DOES NOT APPLY

- Business Regulatory Department cannot participate.
- Bid Packets receive after the established deadline date will be disqualified.

BID COST AND PROPOSALS ARE SEALED SEPARATE

* SHORT LIST IS CREATED BY QUALIFIED PROPOSALS

REQUEST FOR PROPOSAL METHOD

BUSINESS REGULATORY DEPARTMENT

REQUEST FOR PROPOSAL

PHASE I

PHASE II

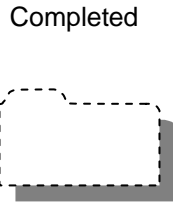
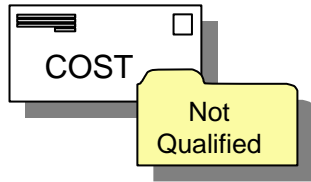

NAV. BUS. OPP. ACT
WILL APPLY

**BID MUST BE AT
MFC OR BELOW
TO BE AWARDED**



PRIORITY # 2

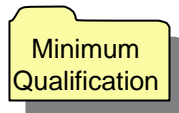
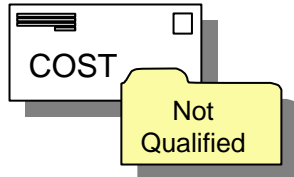

PRIORITY # 1

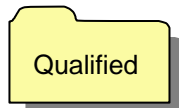

NO PRIORITY

BID COST AND
PROPOSALS ARE
SEALED SEPARATE



SHORT LIST MUST
MEET MINIMAL
REQUIREMENTS

BID OPENING
PROCEDURES WILL
BE FOLLOWED

-SUMMARY-

I . NAVAJO BUSINESS OPPORTUNITY ACT (5 N.N.C. §201 et. seq.)

All procurements exceeding \$50,000 >



~ Requires public advertisement;

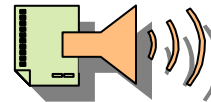

~ Requires bid opening procedures §205;

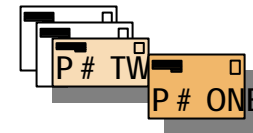

~ Administrative Reviews require clearance by Business Regulatory Department; and



~ DOES NOT require committee oversight approval.



-SUMMARY-

11. NAVAJO BUSINESS PROCUREMENT CODE (12 N.N.C. §301 et. seq.)

All procurements less than < \$50,000 

~ Does not require public advertisement;

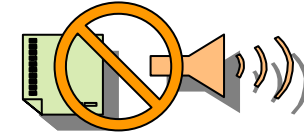

~ Requires CLE/PP to review the BRD Source List
(SMALL PURCHASES, SOLE SOURCE & EMERGENCY PROCUREMENTS)



~ Administrative Review requires clearance by Business Regulatory Department;

~ No committee oversight approval



~ NNPC Does NOT apply to Certified Chapters

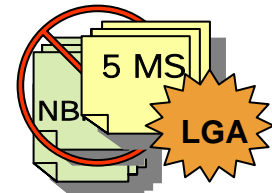

-SUMMARY-

III. ADMINISTRATIVE REVIEW PROCESS (2 N.N.C. §164 B 1,2)

ADMINISTRATIVE REVIEW REQUIRE BUSINESS



REGULATORY CLEARANCE

NO OVERSIGHT COMMITTEE APPROVAL



NO "SAS" PROCESS



RESOLUTIONS ARE NOW CALL "BILLS"

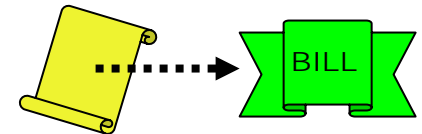

**FINAL APPROVAL MADE BY DIVISION DIRECTOR
OR PRESIDENT**

SIGNATURE APPROVAL



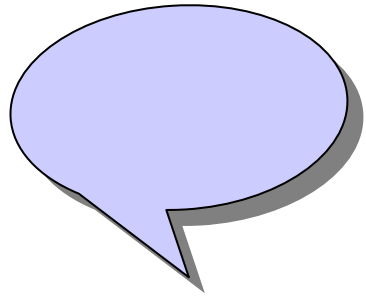

QUESTIONS
COMMENTS
SUGGESTIONS

